

CHAMPION

COMPRESSED AIR SYSTEM | ½" TO 2½"

Quick-Lock Tubing



Why Champion?

Simply stated - There is no equal

Quick-Lock from Champion has taken piping systems to a new level. Without compromising any structural strength, Champion provides an aluminum product that is ten times lighter than steel. This system is easier to install than plastic and delivers a quality of air, nitrogen, vacuum or inert gas that is equal to that of a high cost stainless steel system.

Superior Quality

Champion's Quick-Lock tubing is manufactured from a non-corrosive aluminum that prevents rust and system deterioration while maintaining a high quality of air delivery suitable for all internal and external applications. Champion's piping solution offers superior strength within a lightweight design.

Heralded for its innovative design, Quick-Lock offers the performance of heavy, traditional steel piping, at the cost of systems using plastic. Quick-Lock is secured by nickel-plated brass fittings that provide the deepest level of engagement. Its revolutionary lock-and-seal design ensures a totally safe, leak-free system for all compressed air, vacuum, nitrogen and inert gas applications.



Total Solution

Champion offers a total solution for Compressed Air, Vacuum, Nitrogen and Inert Gas applications. Ranging in size from 14 mm (½") to 63 mm (2½") for Quick-Lock and 70 mm (2½") to 273 mm (10") for Big-Lock, Champion offers four color options to meet all system demands.

With the pairing of Quick-Lock and Big-Lock, Champion can easily provide piping for any application from a 1-2 bay garage to a large industrial manufacturing facility.

Ease of Installation

Champion offers the easiest and fastest installation available. There is no welding, gluing or threading, and very little skill is needed for a professional installation. With the purchase of nylon clips or wire hangers, an installation crew can clip tubing securely to a wall or hang from the ceiling and around beams. No special tools are required and both pieces are easily adjustable for a quick and efficient install.



Available in 4 Color Options

Blue	Compressed Air
Green	Nitrogen
Gray	Vacuum
Black	Inert Gas

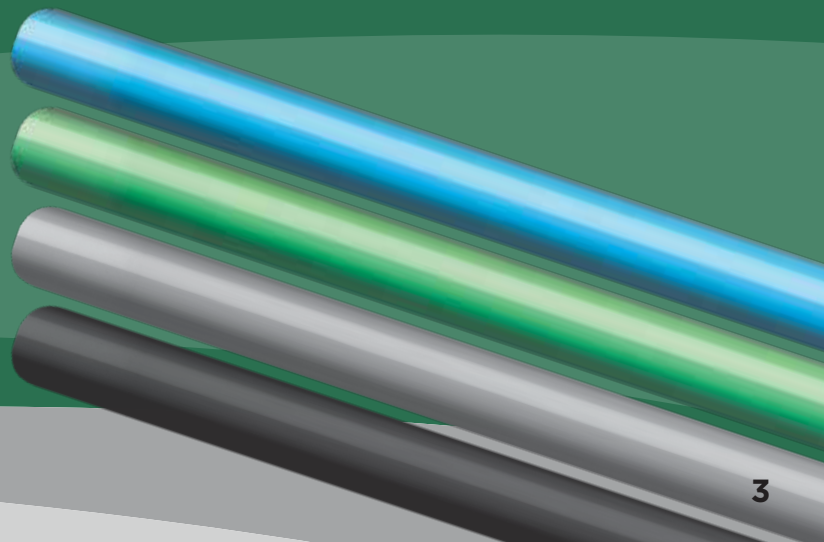

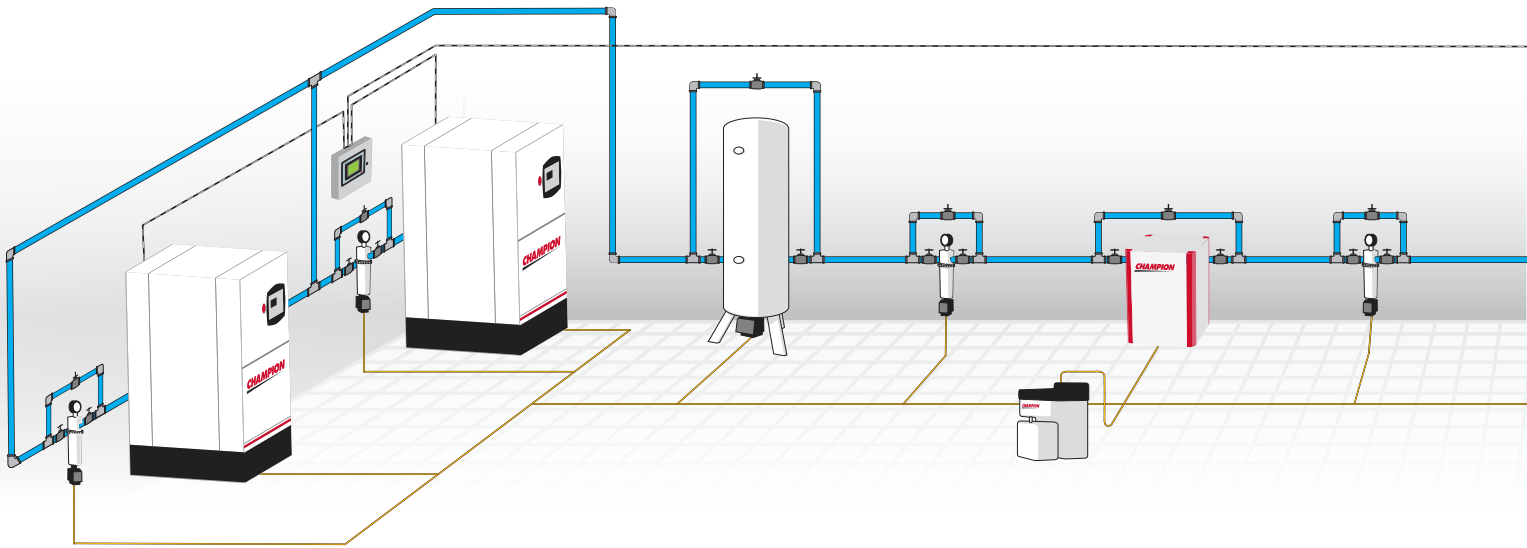

Features & Benefits

- Manufactured from marine-grade aluminum that prevents rust and system deterioration
- Lightest product in the market
- One-tenth the weight of same diameter steel
- High level of structural strength
- Ease of installation compared to competition
- System flexibility allows for simple modifications and/or additions
- High flow rates / low pressure losses
- Smooth internal diameter of tube maintained throughout life of system
- Lowest cost of ownership available
- Enormous level of piping inventory avoids lengthy lead time
- 30 years of combined design and user experience to support customer base

PART	COMPONENT MATERIALS
1	Nut: Nickel-Plated Brass
2	Seal: High Nitrile
3	Clamping Washer: Inox AISI 304
4	O-Ring Seal Made in NBR
5	Safety Ring: Technopolymeric
6	Body: Nickel-Plated Brass

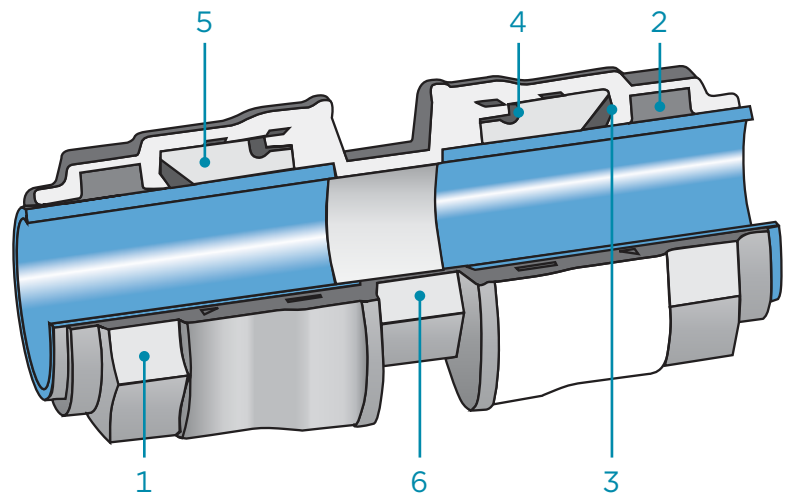

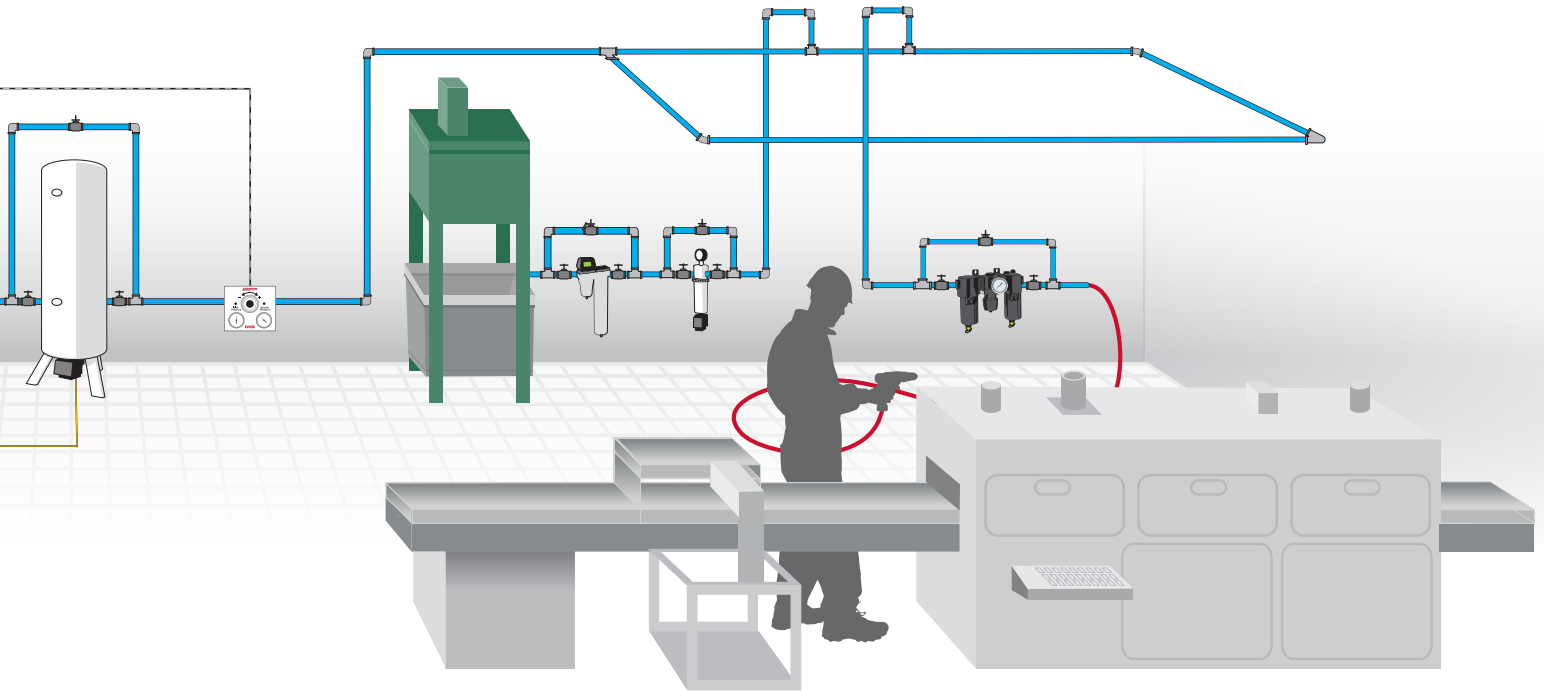

PRESSURES

Minimum Pressure -0.99 bar (-29.6 Hg)

Maximum Pressure 15 bar (220 psi)

COMPATIBLE FLUIDS & GASES

Compressed Air

Vacuum

Inert Gases

THREADS

Male threads taper in conformity with ISO 228

Female threads in conformity with ISO 228

TEMPERATURES

Minimum temperature -4° F (-20° C)

Maximum temperature 176° F (+80° C)

FIRE RESISTANCE

The system does not stoke or propagate any fires

Don't Jeopardize Air Handling Efficiency

Compressed air piping is responsible for the delivery of compressed air to the point of use. Its material, age and condition impact both system reliability and air quality. Compressed air piping made from iron will rust and corrode, creating buildup on the interior and reducing the functional diameter. This buildup results in pressure drop within the system, contributing to high levels of contamination and poor air quality.



High Quality Aluminum Piping Systems

Description Part Number



COMPRESSED AIR PIPING - BLUE

14 mm - .5" Tubing (10 Pack - 8 ft Length) 80 ft	C9000-14-BLUE-PK10
14 mm - .5" Tubing (20 Pack - 8 ft Length) 160 ft	C9000-14-BLUE-PK20
20 mm - .75" Tubing Blue	C9000-20-AIR-BLUE
25 mm - 1" Tubing Blue	C9000-25-AIR-BLUE
32 mm - 1.25" Tubing Blue	C9000-32-AIR-BLUE
40 mm - 1.5" Tubing Blue	C9000-40-AIR-BLUE
50 mm - 2" Tubing Blue	C9000-50-AIR-BLUE
63 mm - 2.5" Tubing Blue	C9000-63-AIR-BLUE



VACUUM PIPING - GREY

14 mm - .5" Tubing (10 Pack - 8 ft Length) 80 ft	C9000-14-GREY-PK10
14 mm - .5" Tubing (20 Pack - 8 ft Length) 160 ft	C9000-14-GREY-PK20
20 mm - .75" Tubing Grey	C9000-20-VAC-GREY
25 mm - 1" Tubing Grey	C9000-25-VAC-GREY
32 mm - 1.25" Tubing Grey	C9000-32-VAC-GREY
40 mm - 1.5" Tubing Grey	C9000-40-VAC-GREY
50 mm - 2" Tubing Grey	C9000-50-VAC-GREY
63 mm - 2.5" Tubing Grey	C9000-63-VAC-GREY



INERT GAS PIPING - BLACK

14 mm - .5" Tubing (10 Pack - 8 ft Length) 80 ft	C9000-14-BLACK-PK10
14 mm - .5" Tubing (20 Pack - 8 ft Length) 160 ft	C9000-14-BLACK-PK20
20 mm - .75" Tubing Black	C9000-20-GAS-BLACK
25 mm - 1" Tubing Black	C9000-25-GAS-BLACK
32 mm - 1.25" Tubing Black	C9000-32-GAS-BLACK
40 mm - 1.5" Tubing Black	C9000-40-GAS-BLACK
50 mm - 2" Tubing Black	C9000-50-GAS-BLACK
63 mm - 2.5" Tubing Black	C9000-63-GAS-BLACK



NITROGEN PIPING - GREEN

14 mm - .5" Tubing (10 pack - 8ft length) 80ft	C9000-14-GRN-PK10
14 mm - .5" Tubing (20 pack - 8ft length) 160ft	C9000-14-GRN-PK20
20 mm - .75" Tubing Green 16' Length	C9000-20-NIT-GRN
25 mm - 1" Tubing Green 16' Length	C9000-25-NIT-GRN
32 mm - 1.25" Tubing Green 16' Length	C9000-32-NIT-GRN
40 mm - 1.50" Tubing Green 16' Length	C9000-40-NIT-GRN
50 mm - 2" Tubing Green 16' Length	C9000-50-NIT-GRN
63 mm - 2.5" Tubing Green 16' Length	C9000-63-NIT-GRN



MALE THREADED CONNECTORS

Straight Male Connector 14 mm x 3/8" NPT	C90011-14-06
Straight Male Connector 14 mm x 1/2" NPT	C90011-14-08
Straight Male Connector 20 mm x 1/2" NPT	C90011-20-08
Straight Male Connector 25 mm x 3/4" NPT	C90011-25-12
Straight Male Connector 32 mm x 1" NPT	C90011-32-16
Straight Male Connector 40 mm x 1 1/2" NPT	C90011-40-24
Straight Male Connector 50 mm x 1 1/2" NPT	C90011-50-24
Straight Male Connector 63 mm x 2" NPT	C90011-63-32

Description Part Number



STRAIGHT UNIONS

Straight Union Connector 14 mm	C90040-14
Straight Union Connector 20 mm	C90040-20
Straight Union Connector 25 mm	C90040-25
Straight Union Connector 32 mm	C90040-32
Straight Union Connector 40 mm	C90040-40
Straight Union Connector 50 mm	C90040-50
Straight Union Connector 63 mm	C90040-63



90° UNION ELBOWS

Union Elbow 14 mm	C90130-14
Union Elbow 20 mm	C90130-20
Union Elbow 25 mm	C90130-25
Union Elbow 32 mm	C90130-32
Union Elbow 40 mm	C90130-40
Union Elbow 50 mm	C90130-50
Union Elbow 63 mm	C90130-63



90° SWIVEL ELBOWS

Swivel Elbow 14 mm 3/8" NPT Male	C90130-14-06
Swivel Elbow 14 mm 1/2" NPT Male	C90130-14-08



45° UNION ELBOWS

Union Elbow 45° 20 mm	C90140-20
Union Elbow 45° 25 mm	C90140-25
Union Elbow 45° 32 mm	C90140-32
Union Elbow 45° 40 mm	C90140-40
Union Elbow 45° 50 mm	C90140-50
Union Elbow 45° 63 mm	C90140-63



TEE UNION

Union Tee 14 mm	C90230-14
-----------------	-----------



TEE SWIVEL

Swivel Tee 14 mm 3/8" NPT Male	C90230-14-06
Swivel Tee 14 mm 1/2" NPT Male	C90230-14-08



EQUAL TEE

Junction Tee 20 mm	C90230-20
Junction Tee 25 mm	C90230-25
Junction Tee 32 mm	C90230-32
Junction Tee 40 mm	C90230-40
Junction Tee 50 mm	C90230-50
Junction Tee 63 mm	C90230-63



OUTLET TEE

Outlet Tee, 20 mm x 20 mm	C90235-20-20
Reduction Outlet Tee 25 mm x 20 mm	C90235-25-20
Reduction Outlet Tee 32 mm x 20 mm	C90235-32-20
Reduction Outlet Tee 32 mm x 25 mm	C90235-32-25
Reduction Outlet Tee 40 mm x 20 mm	C90235-40-20
Reduction Outlet Tee 40 mm x 25 mm	C90235-40-25
Reduction Outlet Tee 50 mm x 20 mm	C90235-50-20
Reduction Outlet Tee 50 mm x 25 mm	C90235-50-25
Reduction Outlet Tee 50 mm x 32 mm	C90235-50-32
Reduction Outlet Tee 63 mm x 20 mm	C90235-63-20
Reduction Outlet Tee 63 mm x 25 mm	C90235-63-25
Reduction Outlet Tee 63 mm x 32 mm	C90235-63-32

Description	Part Number
-------------	-------------

OUTLET, SADDLE CLAMP REDUCER

	Outlet, Saddle Clamp Reducer 32 mm to 20 mm	C90240-32-20
	Outlet, Saddle Clamp Reducer 32 mm to 25 mm	C90240-32-25
	Outlet, Saddle Clamp Reducer 40 mm to 20 mm	C90240-40-20
	Outlet, Saddle Clamp Reducer 40 mm to 25 mm	C90240-40-25
	Outlet, Saddle Clamp Reducer 50 mm to 20 mm	C90240-50-20
	Outlet, Saddle Clamp Reducer 50 mm to 25 mm	C90240-50-25
	Outlet, Saddle Clamp Reducer 63 mm to 20 mm	C90240-63-20
	Outlet, Saddle Clamp Reducer 63 mm to 25 mm	C90240-63-25

CUTTING TOOL, SADDLE CLAMP

	Cutting Tool, 25 mm	C90241-25
	Cutting Tool, 32-40 mm	C90241-32-40
	Cutting Tool, 50-63 mm	C90241-50-63

DRILL JIG, SADDLE CLAMP

	Drill Jig, Saddle Clamp 32 mm	C90242-32
	Drill Jig, Saddle Clamp 40 mm	C90242-40
	Drill Jig, Saddle Clamp 50 mm	C90242-50
	Drill Jig, Saddle Clamp 63 mm	C90242-63

COMPACT SADDLE CLAMP

	Compact Saddle 25 mm x 1/2"	C90248-25-08
	Compact Saddle 32 mm x 1/2"	C90248-32-08
	Compact Saddle 40 mm x 1/2"	C90248-40-08
	Compact Saddle 50 mm x 1/2"	C90248-50-08
	Compact Saddle 63 mm x 1/2"	C90248-63-08

COMPACT SADDLE DRILL JIG

	Compact Saddle Drill Jig 25 mm	C90249-25
	Compact Saddle Drill Jig 32 mm	C90249-32
	Compact Saddle Drill Jig 40 mm	C90249-40
	Compact Saddle Drill Jig 50 mm	C90249-50
	Compact Saddle Drill Jig 63 mm	C90249-63

DRAIN COUPLING

	Drain Coupling 25 mm	C90260-25
	Drain Coupling 32 mm	C90260-32
	Drain Coupling 40 mm	C90260-40
	Drain Coupling 50 mm	C90260-50
	Drain Coupling 63 mm	C90260-63

OUTLET MANIFOLD

	1/2" in, 1/2" out, plus 4 x 1/2"	C90601-MFD
	3/4" in, 1/2" out, plus 4 x 1/2"	C90602-MFD
	Outlet Manifold 3/4" inlet (4 x 1/2" NPT Female outlets)	C90602-MFD
	Outlet Manifold 3/4" inlet (2 x 1/2" NPT Female outlets)	C90602-2-MFD
	Manifold Plug 1/2" NPT w/Seal	C90610-08-NPT
	Manifold Gauge Kit, 300 psi liquid filled	C90601-G

PLUGS

	O-Ring Sealed Plugs, 1/2" NPTM	C90610-08-NPT
---	--------------------------------	---------------

OUTLET ELBOW C/W MTG BRACKET

	Outlet Elbow / Bracket Assy 20 mm x 1/2" NPT	C90601-20-08
	Outlet Elbow / Bracket Assy 25 mm x 1/2" NPT	C90601-25-08
	Outlet Elbow / Bracket Assy 32 mm x 1/2" NPT	C90601-32-08

Description	Part Number
-------------	-------------

DOUBLE OUTLET ELBOW C/W MTG BRACKET

	Double Outlet Elbow / Bracket Assy 20 mm x 1/2" NPT	C90602-20-08
	Double Outlet Elbow / Bracket Assy 25 mm x 1/2" NPT	C90602-25-08

45° DOUBLE OUTLET ELBOW NPT x NPT W/ MTG BRACKET

	45° Double Outlet Elbow 1/2" x 1/2" x 1/2"	C90633-08-08
	45° Double Outlet Elbow 3/4" x 1/2" x 1/2"	C90633-12-08

45° DOUBLE OUTLET ELBOW TUBE x NPT W/ MTG BRACKET

	45° Double Outlet Elbow 20 mm x 1/2"	C90661-20-08
	45° Double Outlet Elbow 25 mm x 1/2"	C90661-25-08

45° DOUBLE OUTLET ELBOW TUBE x NPT W/ VALVE & MTG BRACKET

	45° Double Outlet Elbow w/ Ball Valve 20 mm x 1/2" x 1/2"	C90665-20-08
	45° Double Outlet Elbow w/ Ball Valve 25 mm x 1/2" x 1/2"	C90665-25-08

PLUG - CAP END FITTING

	Plug Cap 14 mm	C90610-14
	Plug Cap 20 mm	C90610-20
	Plug Cap 25 mm	C90610-25
	Plug Cap 32 mm	C90610-32
	Plug Cap 40 mm	C90610-40
	Plug Cap 50 mm	C90610-50
	Plug Cap 63 mm	C90610-63

REDUCER - FITTING BODY TO TUBE

	Reducer, 25 mm Body to 20 mm Tube	C90620-25-20
	Reducer, 32 mm Body to 20 mm Tube	C90620-32-20
	Reducer, 32 mm Body to 25 mm Tube	C90620-32-25
	Reducer, 40 mm Body to 20 mm Tube	C90620-40-20
	Reducer, 40 mm Body to 25 mm Tube	C90620-40-25
	Reducer, 40 mm Body to 32 mm Tube	C90620-40-32
	Reducer, 50 mm Body to 25 mm Tube	C90620-50-25
	Reducer, 50 mm Body to 32 mm Tube	C90620-50-32
	Reducer, 50 mm Body to 40 mm Tube	C90620-50-40
	Reducer, 63 mm Body to 40 mm Tube	C90620-63-40
	Reducer, 63 mm Body to 50 mm Tube	C90620-63-50

STEM ADAPTER - MALE

	Stem Adapter, 20 mm x 1/2" NPTM	C90626-20-08M
	Stem Adapter, 20 mm x 3/4" NPTM	C90626-20-12M
	Stem Adapter, 25 mm x 1/2" NPTM	C90626-25-08M
	Stem Adapter, 25 mm x 3/4" NPTM	C90626-25-12M
	Stem Adapter, 25 mm x 1" NPTM	C90626-25-16M
	Stem Adapter, 32 mm x 1" NPTM	C90626-32-16M
	Stem Adapter, 32 mm x 1 1/2" NPTM	C90626-32-24M
	Stem Adapter, 40 mm x 1 1/2" NPTM	C90626-40-24M
	Stem Adapter, 50 mm x 1 1/2" NPTM	C90626-50-24M
	Stem Adapter, 50 mm x 2" NPTM	C90626-50-32M
	Stem Adapter, 63 mm x 2" NPTM	C90626-63-32M
	Stem Adapter, 63 mm x 2 1/2" NPTM	C90626-63-40M

Description	Part Number
-------------	-------------



Stem Adapter, 20 mm x 1/2" NPTF	C90626-20-08
---------------------------------	--------------

BALL VALVES - TUBE TO TUBE



Ball Valve, 14 mm Tube	C90700-14
Ball Valve, 20 mm Tube	C90700-20
Ball Valve, 25 mm Tube	C90700-25
Ball Valve, 32 mm Tube	C90700-32
Ball Valve, 40 mm Tube	C90700-40
Ball Valve, 50 mm Tube	C90700-50
Ball Valve, 63 mm Tube	C90700-63

BALL VALVES - TUBE TO NPT



Ball Valve, 20 mm to 1/2" MNPT	C90721-20-08
Ball Valve, 25 mm to 3/4" MNPT	C90721-25-12

STRUT BRACKET (PACK OF 10)



Tube mm	Inches	Part Number
14	.5	C90810-14-PK-10
20	.75	C90810-20-PK-10
25	1	C90810-25-PK-10
32	1.25	C90810-32-PK-10
40	1.5	C90810-40-PK-10
50	2	C90810-50-PK-10
63	2.5	C90810-63-PK-10

WALL BRACKET (PACK OF 10)



Tube mm	Inches	Part Number
14	.5	C98010-14-PK-10-W

WALL BRACKET WITH SPACER (EACH)



Tube mm	Inches	Part Number
20	.75	C90815-20-WSP
25	1	C90815-25-WSP
32	1.25	C90815-32-WSP
40	1.5	C90815-40-WSP
50	2	C90815-50-WSP
63	2.5	C90815-63-WSP

TEARDROP HANGING BRACKET (EACH)



Bracket, Hanging - Teardrop 20 mm, 3/8" insert	C90820-20-25-TD
Bracket, Hanging - Teardrop 20 mm, 3/8" insert	C90820-20-25-TD
Bracket, Hanging - Teardrop 25 mm, 3/8" insert	C90820-20-25-TD
Bracket, Hanging - Teardrop 32 mm, 3/8" insert	C90820-32-TD
Bracket, Hanging - Teardrop 40 mm, 3/8" insert	C90820-40-TD
Bracket, Hanging - Teardrop 50 mm, 3/8" insert	C90820-50-TD
Bracket, Hanging - Teardrop 63 mm, 3/8" insert	C90820-63-TD

WIRE HANGING SYSTEM (PACK OF 10)



20-63 mm, 15 ft. long, 3/8" stud	C90832-15
20-63 mm, 15 ft. long, 1/4" stud	C90831-15

CANTILEVER BRACKET



Cantilever Wall Bracket	C90830
-------------------------	--------

OUTLET "Y" ADAPTOR



Outlet Y Adaptor 1/2" Male c/w 2 x 1/2" Female NPT	C82600-08-08
--	--------------

Description	Part Number
-------------	-------------



BALL VALVES - NPT

Ball Valve, 3/8" M x 3/8" F NPT	C86310-06-06
Ball Valve, 1/2" F x 1/2" F NPT	C86300-08-08
Ball Valve, 1/2" M x 1/2" F NPT	C86310-08-08

QUICK COUPLERS



Universal Socket, 1/4" NPT Male	C80191-04
Universal Socket, 3/8" NPT Male	C80191-06
Universal Socket, 1/2" NPT Male	C80191-08
Universal Socket, 1/4" NPT Female	C80192-04
Universal Socket, 3/8" NPT Female	C80192-06
Universal Socket, 1/2" NPT Female	C80192-08
Universal Socket, 1/4" Hose Barb	C80193-04
Universal Socket, 3/8" Hose Barb	C80193-06
Universal Socket, 1/2" Hose Barb	C80193-08
Plug, 1/4" NPT Male	C80221-04
Plug, 3/8" NPT Male	C80221-06
Plug, 1/2" NPT Male	C80221-08
Plug, 1/4" NPT Female	C80222-04
Plug, 3/8" NPT Female	C80222-06
Plug, 1/2" NPT Female	C80222-08
Plug, 1/4" Hose Barb	C80223-04
Plug, 3/8" Hose Barb	C80223-06
Plug, 1/2" Hose Barb	C80223-08

TOOLING



Tube Cutter	C90870
Deburr Tool	C90880

XXM FLOW CONTROLLER



XXM Flow Controller, 75 cfm	XXM75
XXM Flow Controller, 200 cfm	XXM200
XXM Flow Controller, 1000 cfm	XXM1000

* Specify flow direction for unit when ordering

ELECTRONIC DRAIN VALVES



Electronic Timer Drain Valve, 1/4" NPT W/Strainer	C90900-04
Electronic Timer Drain Valve, 1/2" NPT W/Strainer	C90900-08

ZERO LOSS DRAIN VALVE



Flow Rate 200 scfm	CZLD-200
Flow Rate 500 scfm	CZLD-500
Flow Rate 500 scfm - HP*	CZLD-500-HP
Flow Rate 2,000 scfm	CZLD-2000

* Non stock, special order

SAMPLES

Quick-Lock Demo Kit, pipe & fittings w/case 14 mm	C90952
Quick-Lock Demo Kit, pipe & fittings w/case 20-63 mm	C90951

GARAGE PIPING KITS *

Quick-Lock Garage Kit (1-2 Bay)	CGK-1-2
Quick-Lock Garage Kit (3-4 Bay)	CGK-3-4

* See brochure GA-QLT-KIT for more details

Quick-Lock Tubing Installation Instructions

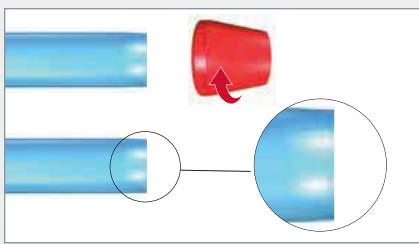

1. Remove burrs from the outside diameter of the tube. Clean and remove any shavings.



2. Add oil on tube before inserting into the fitting.



3. Fittings D14, D20, D25, D32 and D40mm are supplied fully assembled. Insert the tube into the fitting. To make insertion easier, rotate the tube on itself while making the connection. Be sure tubing is securely and fully inserted into the fitting.



4. Use the following table to properly tighten the fittings:

TUBE DIAMETER	TORQUE
14	Push lock, no torque needed.
20	300 cN.m (26 in-lbs)
25	300 cN.m (26 in-lbs)
32	400 cN.m (35 in-lbs)
40	650 cN.m (58 in-lbs)

5. Only for tube dimensions D50 and D63mm. To facilitate installation, fittings are supplied with unscrewed nuts. Once the tab is inserted into the fitting, tighten the nuts to the torque specified below:

TUBE DIAMETER	TORQUE
50	65 N.m (48 ft-lbs)
20	65 N.m (48 ft-lbs)

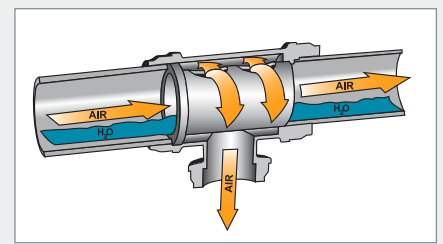

Outlet/Reducing Tee Fitting

This fitting is a valid alternative to the traditional swan neck, and proves itself as a fast and low-cost solution. The efficient internal system allows air to reach the point-of-use and drain toward the most convenient low point of the system, so that no moisture stays within the main circuit. This fitting is also an alternative to a traditional goose neck (up and over) take-off point. It prevents water from dropping out of the main piping loop into the drop line. All systems should be installed with a slight slope to allow moisture to collect at one point in the system. This point should be fitted with a drop line and terminated with a condensate drain.

CAUTION!

Do not loosen the compression nuts prior to pipe installation. The fitting compression nuts are torqued at the factory. To install the pipe, push and rotate the pipe into the fitting until fully seated. Verify the compression nuts are tightened to the proper torque displayed in the above tables.

PIPE REMOVAL:

Loosen the fitting compression nut 1 to 1.5 turns, push the pipe into the fitting and then pull out.

Quick-Lock Tubing System Test Procedure

WARNING! Before pressurizing the system, the following instructions must be carried out.

- Check that all nuts on body of fittings are securely tightened.
- Insure that all tubing is fully inserted into each fitting.
- Insure that all mounting and hanging brackets are securely fastened to a solid structure and to the tubing.
- Insure that a safety relief valve is installed and fully operational in the system to prevent over-pressurization.
- Insure that an isolation valve is installed between the compressor(s) and the piping system and is in a "closed" position. Install a pressure gauge downstream of the isolation valve so that system pressure can be viewed when isolation valve is in either open/closed position.
- Close all outlet points in piping system.
- Insure that the test area is vacated for the duration of the pressure test.
- Open isolation valve slowly and allow system pressure to build to 15 psig and then close the valve. Hold pressure for 10 minutes and inspect system for any leakage or joint slippage. If system is secure, repeat the 15 psig increments, making the required checks, until the maximum working pressure is reached.
- When full system working pressure is achieved, hold system pressure for 1 hour. (Max. working pressure must not exceed 220 psig.)
- Re-inspect system for leakage and loose/slipping joints.
- If any faults are found in the system, depressurize the system, correct the faults and retest.

Lifetime Warranty

Champion is proud to provide our Lifetime Warranty Program covering all pipe and fittings for the Quick-Lock and Big-Lock compressed air product lines. This warranty is possible due to the long history of producing high quality products, continuing our tradition of excellence and customer satisfaction.

We are 100% committed to supplying the finest products available to our customers and always doing our best to exceed their expectations. This Lifetime Warranty is a testament to that commitment!



LIFETIME
WARRANTY PROGRAM

QUICK-LOCK TUBING FLOW RATES

TUBE INTERNAL DIAMETER		CFM @ 125 PSIG	CFM @ 150 PSIG	CFM @ 175 PSIG	CFM @ 220 PSIG
MM	IN.				
14	0.50	12	14	17	21
20	0.75	36	39	42	48
25	1.00	76	81	88	99
32	1.25	146	158	171	189
40	1.50	266	291	310	348
50	2.00	476	526	565	627
63	2.50	881	965	1047	1153

Flow rates are based on a 1 psi pressure drop per 100 ft (65 ft for 14 mm tubing) run of tube and couplings in a "straight line". For loop systems, flow rates can be doubled.

TECHNICAL INFORMATION - C9000 CALIBRATED ALUMINUM TUBING

OUTSIDE DIAMETER		MAXIMUM PRESSURE BARG / PSIG	WEIGHT LBS / FT	LENGTH FT
MM	IN.			
14	0.50	15 / 220	0.098	8
20	0.75	15 / 220	0.159	16
25	1.00	15 / 220	0.202	16
32	1.25	15 / 220	0.262	16
40	1.50	15 / 220	0.331	16
50	2.00	15 / 220	0.592	16
63	2.50	15 / 220	0.623	16

TECHNICAL SPECIFICATIONS OF TUBING

PROPERTIES	PROPERTY SPECIFICATIONS
Extruded Aluminum	UNI 9006/1 Al Mg 0.5 Si 0.4 Fe 0.2
Chemical Composition	Si: 0.3 ÷ 0.6 - Mg: 0.35 ÷ 0.6 - Fe: 0.10 ÷ 0.30
Designations	UNI EN 573 - 3 EN AW 6063
Heat Treatment	Bonificato "T5"/ Drained "T5"
Surface Treatment	Electrostatic painting
Specific Weight	2.70 Kg/dm ³
Specific Resistance	3.25 cm
Thermal Conductivity	1.75 W/(cm °K)
Expansion Coefficient	0.024 mm/(m °C)
Specific Heat @ 100° C (212° F)	0.92 J/(g °K)
Bearing Tensile Stress	205 N/mm ²
Coefficient of Elasticity	66000 N/mm ²
Proportionality Deviation Load	165 N/mm ²
Brinell Hardness	60 ÷ 70 HB
Melting Point	600° C (1112° F)
Percentage Elongation	10%

Sales & Service **Distributors** Across America

An Extensive Network

Your sales, service and technical support needs will be handled quickly and easily by our extensive network of Champion factory-trained, authorized local distributors. Maintaining and adequately servicing your compressor has never been easier.



Champion is committed to
delivering **superior products** built with
the **exceptional standards** you expect.

CHAMPION[®]

1301 North Euclid Avenue
Princeton, Illinois 61356 USA
866-276-4330
www.ChampionPneumatic.com

