

# BL SERIES

## Bench-Mounted Combination Brake Lathe



Turn a profit for your shop



Anti-Chatter Technology  
(optional)



Digi-Cal measurement  
(optional)



Adjustable feed rate



Flexible workspace  
configurations available



## BL Series brake lathe at-a-glance

# THERE'S A LOT GOING ON UNDER THE HOOD

The Hunter BL Series Brake Lathe's flexibility allows for accurate servicing of both rotors and drums.



### OPTIONAL, PATENTED

## Anti-Chatter Technology

- ✓ Oscillates machining speed to prevent buildup of vibration (chatter)
- ✓ No bands or other devices required



### OPTIONAL

## Digi-Cal measurement

- ✓ Determine if workpiece should be discarded prior to machining
- ✓ Accurately determines depth of cut
- ✓ Perform one-cut service



### OPTIONAL

## Touchscreen interface

- ✓ Instant access to rotor specs
- ✓ Thickness and depth cut display
- ✓ On-board operation videos



### STANDARD

## Quick change

- ✓ Twin cutters pivot to quickly change from rotors to drums
- ✓ No storing of cutting head required



### STANDARD

## Disc/drum control lockout

- ✓ Prevents "crashing" of machine
- ✓ Warning indication reminder



### STANDARD

## Adjustable feed rate

- ✓ Dial fast for rapid removal or slow for final surface finish
- ✓ One-cut pass capable

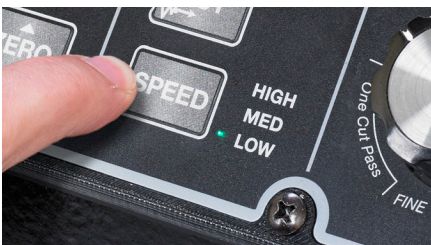

### OPTIONAL

## Push-button speed control

- ✓ Three working speeds
- ✓ Eliminates belt changes



### STANDARD

## Dual LED work lamps

- ✓ Illuminate both sides of workpiece
- ✓ Fully adjustable push-button control



### OPTIONAL

## Mobile bench

- ✓ Heavy-duty, covered adaptor storage
- ✓ Large, locking casters



Proudly made  
in Durant, MS



### Self-aligning nut

- ✓ Speeds setup
- ✓ Prevents over-tightening and mounting errors

*BL73 Includes tablet interface, ACT / Digi-Cal 2.0 package, rotor capability, bench and dust collection hood. Shown with optional adaptors.*

# ENOUGH WITH THE CHATTER

Anti-Chatter Technology eliminates buildup of vibration – stop chatter before it starts!

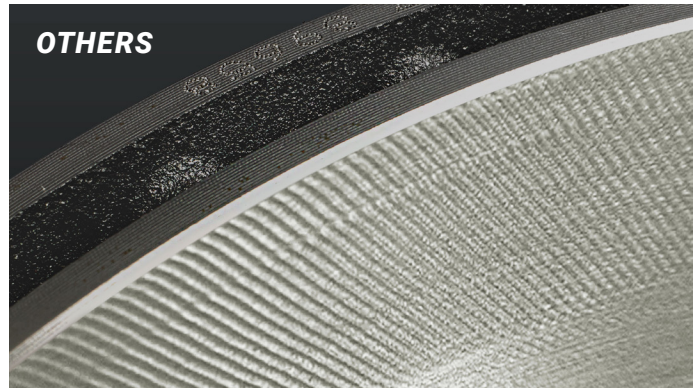
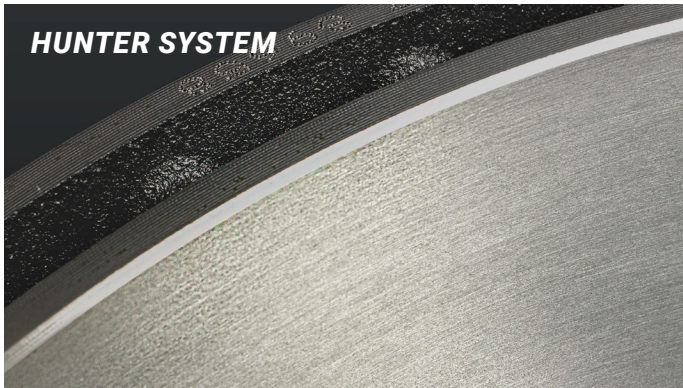

## Oscillating speed

Anti-Chatter Technology (ACT) varies spindle speed to keep chatter-inducing vibration from starting, resulting in a smoother surface finish.

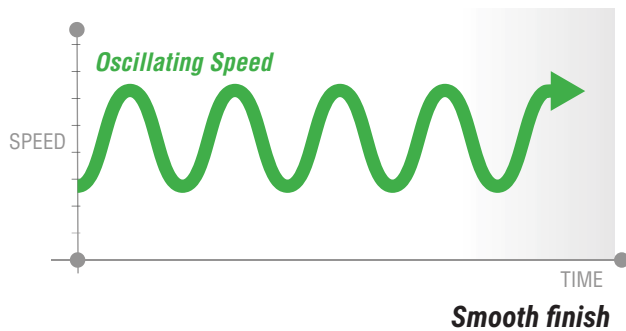



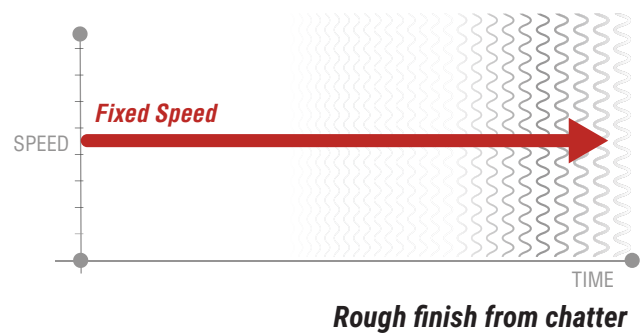

## Fixed speed

Chatter can start when machining rotors at a fixed speed. This is similar to how a moistened finger can make a crystal glass sing.



## Digi-Cal measurement

# MEASURE ROTOR DIMENSIONS AND DEPTH OF CUT

-  Measuring system is located at the end of the cutter shaft
-  Bright LED illuminates the backside of the rotor
-  Does not lose calibration when turned off or stored
-  Dimensions turn red on the screen when attempting to cut rotor below manufacturer's specification. (requires tablet option)
-  No hand tools required

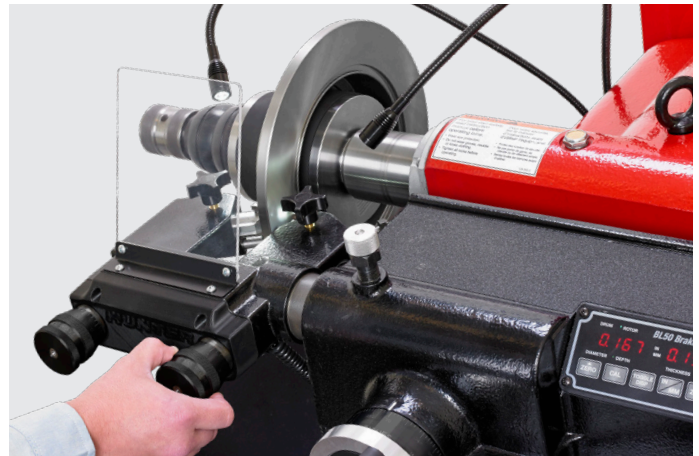

*Touchscreen interface (optional)*

# FULL CONTROL OF THE CUT

- ✓ Compare thickness and diameter to OE specs
- ✓ On-screen messages and animations make technicians more efficient
- ✓ Bit Minder tracks bit usage
- ✓ Training videos, multiple languages and more



*Adjust and calibrate*

# FROM ROTORS TO DRUMS, AND BACK AGAIN

## Change brake type in seconds

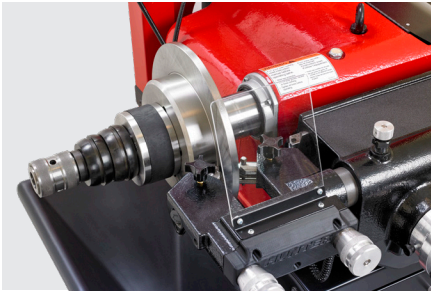

### STEP 1

Change from rotors to drums...

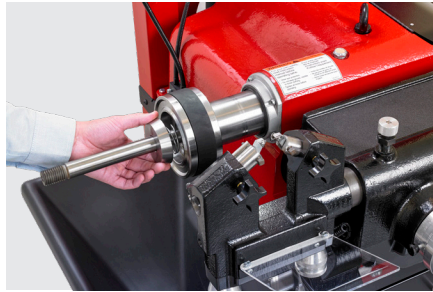

### STEP 2

... by loosening clamp screw, removing rotor setup, rotating twin cutter...

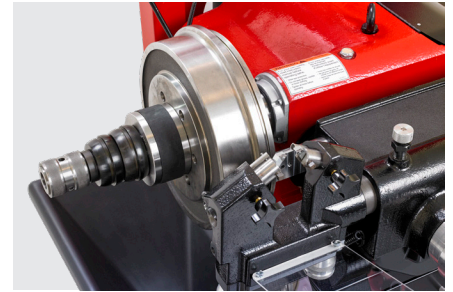

### STEP 3

and set up drum service assembly and extend drum boring bar

## Control the speed



ACT / DIGI-CAL 2.0 PACKAGE

### Push Button Speed

✓ Push button control with three working speeds

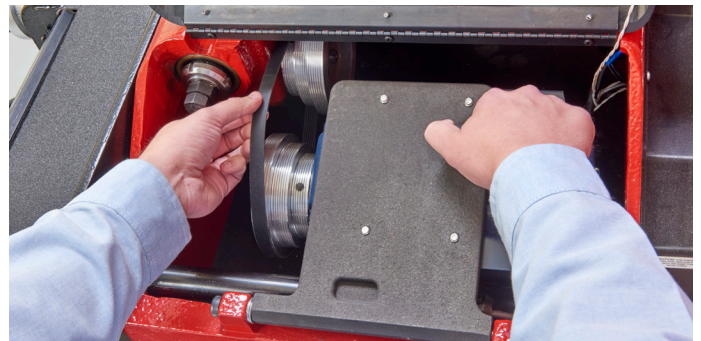

STANDARD

### Adjustable Spindle Speeds

✓ Provides correct speed for all size workpieces

✓ No tools required

## Optional equipment

# BUILD IT TO FIT YOUR SHOP



### Bench

- ✓ Heavy-gauge, all-steel construction
- ✓ Hang frequently used adaptors
- ✓ Large chip collection funnel keeps debris off the floor
- ✓ Includes storage drawer and document holder

*BL71 shown includes tablet interface, ACT / Digi-Cal 2.0 package, rotor capability, and bench. Shown with optional adaptors.*

### Mobile bench with chip funnel – 20-4066-1

Flexibility and adaptability for your shop

- ✓ Heavy-duty, covered adaptor storage
- ✓ Large, locking casters

*Compatible with Dust Containment System (20-3991-1)*



### OPTIONAL

### Dust containment system

- ✓ Designed to contain brake machining dust and metal particles
  - ✓ Access window allows easy viewing of workpiece during machining
- Requires a conventional shop vacuum with 2.5" inlet hose (not supplied).*

### PATENTED

## Hunter Passenger Car and Light Truck Adaptor Kits

Customize your Hunter BL series lathe to match your service needs. Select the appropriate adaptor kit to service most rotors, drums and flywheels.

### Basic adaptor kit –20-1665-1

For passenger cars

### Dual QuickChuck™ adaptor kit – 20-2614-1

For passenger cars, light trucks and larger light trucks

### Elite cone adaptor kit – 20-2615-1

For passenger cars, light trucks and larger light trucks

### Dual QuickChuck™ adaptor – 175-423-2

Quick setup and unparalleled centering ability, ideal for hubless drums

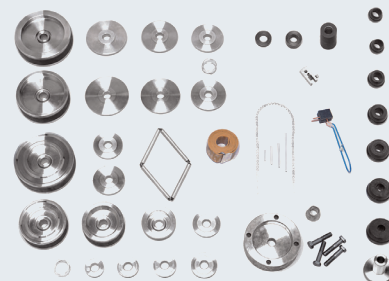

*Elite Cone Adaptor Kit (20-2615-1) shown*



Refer to the Brake Lathe Accessories document (LB03947-00) for more adaptor kit information.

# SPECIFICATIONS

Rotor Diameter*	6 - 22 in. (152.4 - 584.2 mm)
Rotor Max Width	5 3/8 in. (136.5 mm)
Rotor Max Thickness	2 in. (50.8 mm)
Drum Diameter*	6 - 24 in. (152.4 - 609.6 mm)
Drum Max Width	8 in. (203.2 mm)
Max Weight on 1 7/8" arbor	200 lbs (90.7 kg)
Motor	1.5 hp (1.12 kw)
Spindle Speeds	85 / 110 / 175 rpm
Feed Rate	002 - .014 in. / rev (.05 - .36 mm/rev.) Infinitely variable
Power Requirements	115/230 V, 15/7.5 amp, 50/60 Hz, 1ph
Shipping Weight	488 lbs. (approx.)



BL73 shown with optional bench, hood and tablet.

\* The max rotor and drum diameter is 19.5" with the hood installed.

Models	BL73	BL71	BL70	BL13	BL11	BL10
Tablet	✓	✓	✓			
Rotor Capability	✓	✓	✓	✓	✓	✓
ACT/Digi-Cal 2.0	✓	✓	✓			
Bench	✓	✓		✓	✓	
Dust Collection Hood	✓			✓		

## Measurements

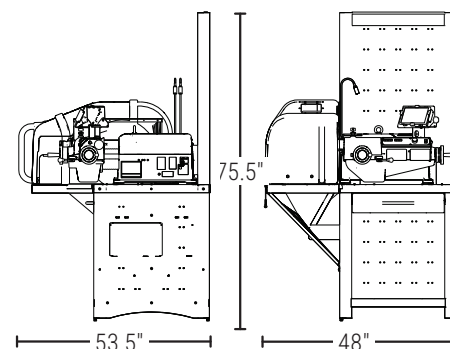

Some specifications may vary depending upon workpiece configurations or require optional adaptors.

## Your local Hunter team is ready to help

- ✂ Receive same- or next-day service
- 📞 Get a free quote or on-site demo
- 🎓 Register for ASE-accredited training courses
- 📖 General information and questions



Contact your local team

[hunter.com/contact](https://hunter.com/contact)

Because of continuing technological advances, specifications, models and options are subject to change without notice.

HunterNet is a registered trademark of Hunter Engineering Company.



**HUNTER**  
Engineering Company

[www.hunter.com](https://www.hunter.com)