

Lift Rack Accessories



Visit hunter.com/shop to order select genuine Hunter® lift rack consumable parts online.
Outside the U.S.? Use the link to get in touch with your local Hunter team.



SWING AIR JACKS

Hunter Swing Air Jacks provide reliable, full-pneumatic lifting capacity with low drive-on height.

Proven over decades of use, air-operated cylinders raise the vehicle from either the suspension or frame. Swing air jacks are engineered to handle a wide variety of vehicles and provide easy, low-maintenance service.



9,000-lb. Capacity, Triple Composite Cylinder Jack – 133-84-1

Ideal for use with RX16, L45x lift models.



6,000-lb. Capacity, Dual Composite Cylinder Jack – 133-85-1

Ideal for use with RX-10 and RX12A lift models.



Swing Air Jack clearances

A	Clearance	1.5 in.
B	Max. Low Flip	16 in.
C	Max. High Flip	18 in.

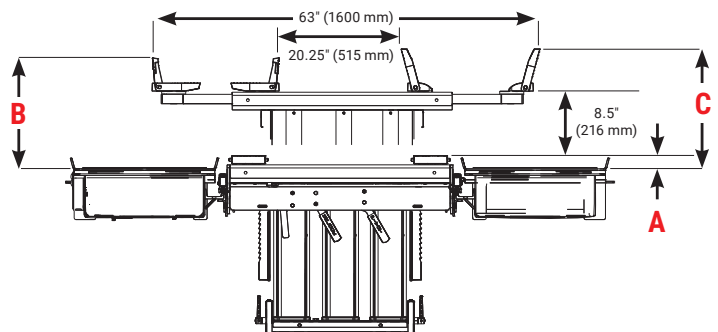

ALIGNLIGHTS

The AlignLights system provides a safe and efficient LED light source underneath the vehicle without additional electrical cords.

The lights automatically switch on when the lift is raised and off when the lift is lowered.

20-3438-1 – for RX_K models only

20-2993-1 – for L45x models

20-3745-1 – for L494HD models

AlignLights is an ALI listed accessory for all lift models.



AlignLights is available for most Hunter alignment lifts as an installed option or can be retrofitted to most previously installed lifts.



TURNPLATES

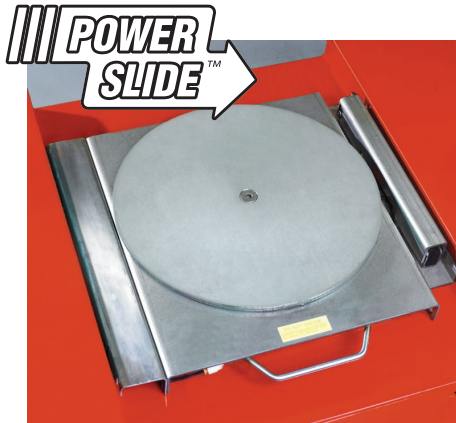

PowerSlide® Turnplates

PowerSlide® turnplates eliminate the hassle of removing and replacing lock pins during an alignment. Integrated bridges lower and raise as plates are locked. PowerSlide® turnplates are an optional feature that may be added later to qualified RX and Four-Post series lifts.

20-2076-1	PowerSlide® turnplates with automatic bridges	For use with camera-based alignment sensors
-----------	---	---



Stainless Steel Turnplates

Resists corrosion and maintains free movement during the alignment procedure. Stainless steel construction for long, trouble-free life. No pointer.

20-2532-1	Stainless Steel (set of 2)	Fits 1.5" or 50 mm turnplate pockets <i>Includes guide strips</i>
20-2533-1	Stainless Steel, Low Friction (set of 2)	Fits 50 mm turnplate pockets <i>Includes guide strips</i>



Painted Turnplates

20-2531-1BLK

Set of two turnplates for 1.5" or 50 mm turnplate pockets. Steel construction with a powder-coated paint finish. No pointer.



Turnplate Bridge

Eases rolling compensation when rack is used with camera-based alignment sensors.

20-2307-1 Universal Bridge for 50 mm and 1.5" turnplate pockets

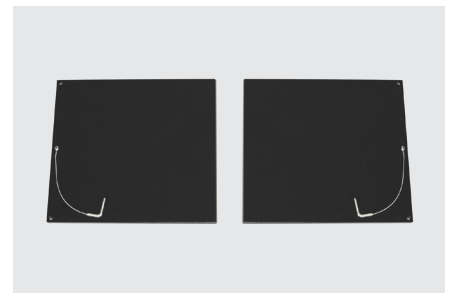

Filler Plates

Fills turnplate pockets when turnplates are not used. 19.5" wide.

20-2395-1BLK For 50 mm pockets (two included)

RAMPS AND EXTENSIONS

High-floor-slope conditions and low-ground-clearance vehicles occasionally require additional approach ramp length.

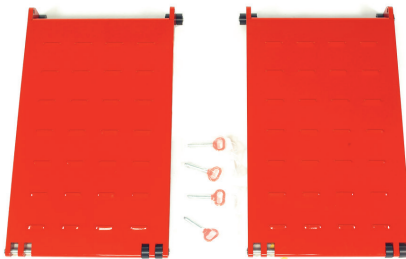

Stage 2 RX Approach Ramp Extensions

(Only available in red or black)

20-3113-1	RX ramp extension kit (set of 2)	Adds 17.75" length to ramps for: RX10K, RX9, RX10, and RX16 <i>Standard on RXDC, RX12K, and RX14K</i>
20-2189-1	RX ramp extension (incl. quick-release pins)	Adds 50" length to ramps for: RX10K, RX9, RX10, and RX16 Adds 37.25" length to ramps for: RX-12, RX12A, RX12K, and RX14K

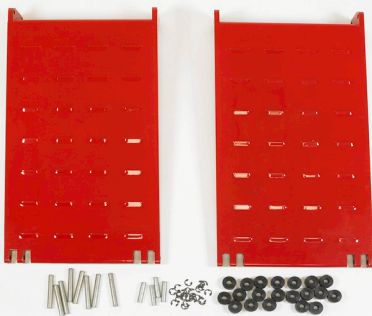
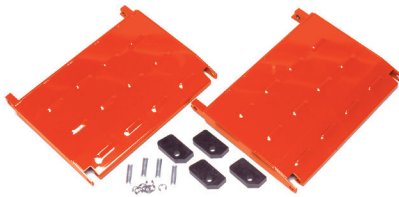

Stage 2 Four-Post Ramp Extension Kit

(Only available in red or black)

20-3145-1	Four-Post ramp extension for 26-in. runways	Adds 17.5" length to ramps
20-3146-1	Four-Post ramp extension for 26-in. runways	Adds 40" length to ramps

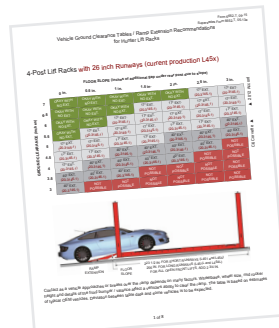

Refer to form **6652-T** for ramp extension recommendations based on vehicle ground clearance.

RAMPS AND EXTENSIONS CONT.

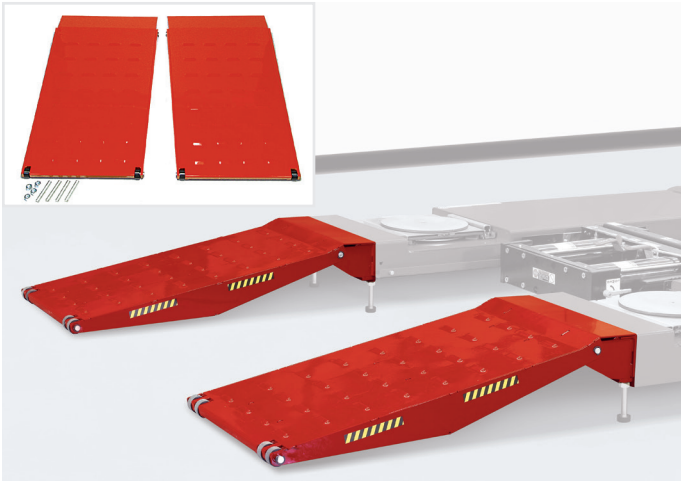

Drive-Thru Kit – 20-2498-1

(Only available in red or black)

Drive-thru kit for use with camera sensors. Adds 52" to overall length.

Compatible with the following models:

- ✓ RX10K, RX12K, and RX14K
- ✓ Legacy RX10, RX12A, and RX16 racks



Flush-Mount Conversion Kit – 20-2736-1

(Only available in red or black)

Converts surface-mount installations to flush-mount installations, using current site requirements.

Compatible with the following models:

- ✓ RX10K and RX12K
- ✓ Legacy RX10 and RX12A racks

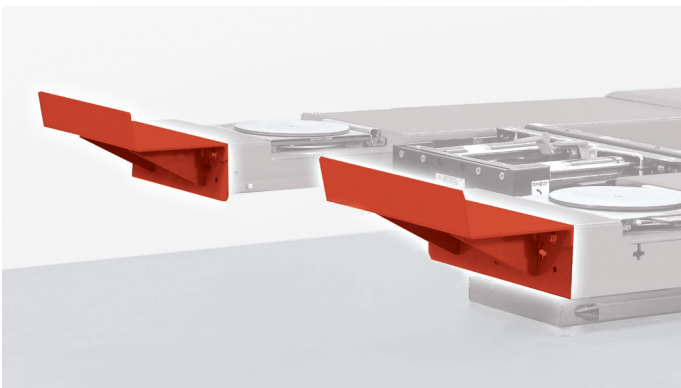

Long Wheel Stops – 20-2497-1

(Only available in red or black)

For use with conventional sensors and vehicles with low spoilers. Adds approximately 12" in length

Compatible with the following models:

- ✓ RX10K and RX12K
- ✓ Legacy RX10, RX12A, RX16, and RX14K racks
- ✗ Not compatible with current RX14KL and RX16KLF

ADDITIONAL LIFT ACCESSORIES

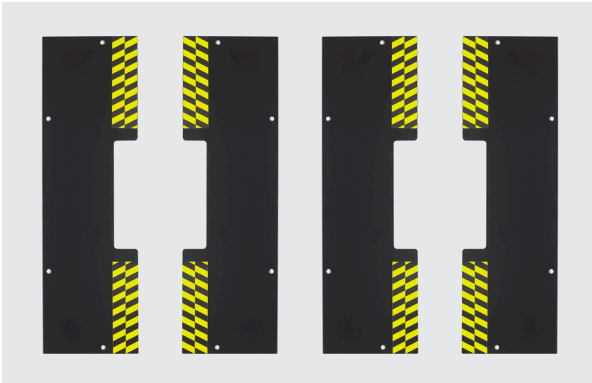

Pit Hose Reel Cover Plates (set of 4) 20-2267-1

Cover plate for InflationStation™ lifts to trim around flush-mount cut-outs.

51-2308-1 Single pit hose reel cover plate



Work Step – 51-1696-1

Work step makes custom steer or underhood shim work easier. Can be used with RX, L45X, L42X, L44X, RM, PN and RMHD models.

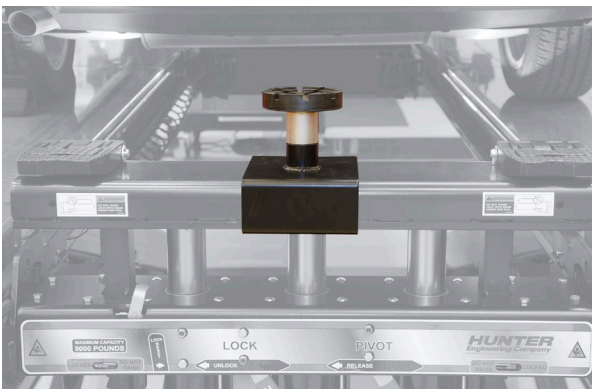

Center Lift Jack Adaptor 20-2854-1 (6,000 lb) 20-2853-1 (9,000 lb)

Ideal accessory for lifting from the differential or subframe on many vehicles. Includes storage bracket.

Suitable for 133-84-1 and 133-85-1 jacks only.

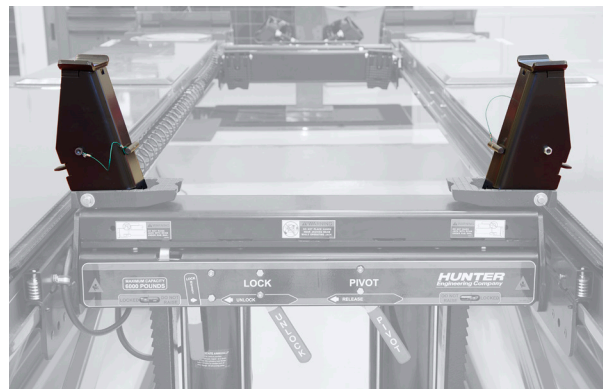

Jack Riser Kit (set of 2) – 20-2801-1

Extends the reach of the jack to make lifting high-ground-clearance and long-wheelbase vehicles easier. Adds 4.5" to overall jack lift height.

Suitable for 133-84-1 and 133-85-1 jacks only.



Front-Mount Power Unit Bracket – 20-3072-1

For L45x models

Moves power unit mounting to front of four-post column for bays with very little space.

ADDITIONAL LIFT ACCESSORIES



Storage Bracket Kit 20-2528-1

Provides storage for wheel adaptors on console, lift or HawkEye Elite® sensor column. Simply bolts on to clip-on work step holes, no drilling required. Includes four brackets.

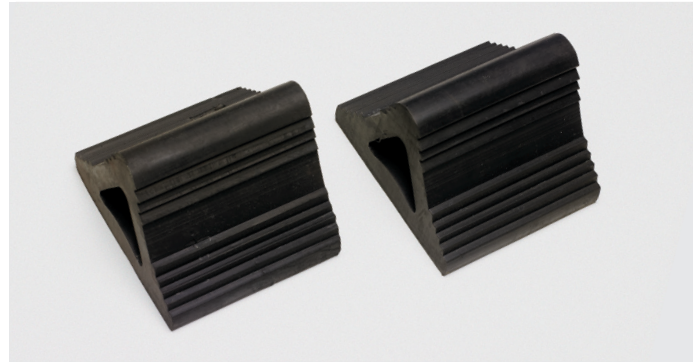

Wheel Chock – 22-525-2

Prevents vehicle from rolling once on the lift. Two chocks are included standard in any new lift purchase.

Your local Hunter team is ready to help

- ✂ Receive same- or next-day service
- 🏠 Get a free quote or on-site demo
- 📅 Register for ASE-accredited training courses
- 🗨 General information and questions



Contact your local team

hunter.com/contact

Because of continuing technological advances, specifications, models and options are subject to change without notice.

HawkEye Elite and PowerSlide are registered trademarks of Hunter Engineering Company. The PowerSlide logo and InflationStation are trademarks of Hunter Engineering Company.

0724FH

Copyright © 2024, Hunter Engineering Company

HUNTER
Engineering Company

www.hunter.com

Form RB05262-00, 07/24

Supersedes form RB05262-00, 08/23